



Hartau Series

Hartau Table

The Hartau series brings together classical light fittings that are, at first glance, astonishing in their line and detail. They have been handmade in Canada using frosted glass, brass and painted aluminium and alabaster.

The lampshades are the signature of this collection: with their two openings they offer both direct and indirect light. Each metal part of the Hartau collection is precision made in Quebec, Canada.

Design by Alexandre Joncas

HARTAU table

Design by Alexandre Joncas

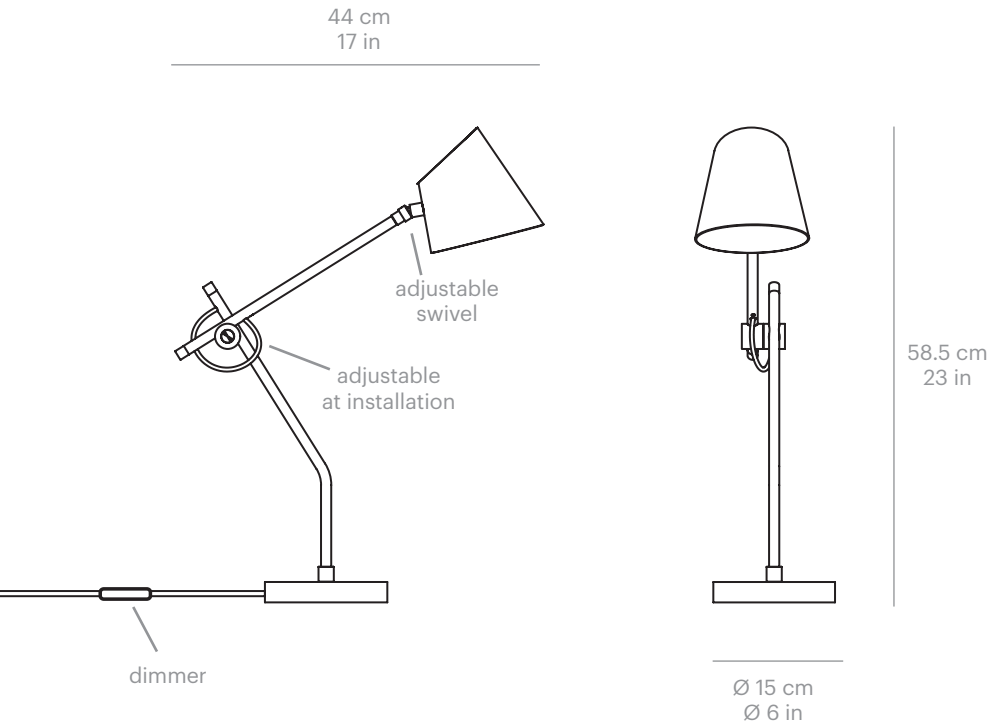









Lamping Specifications
 Input voltage : 120V or 220-240V
 Power input : 5W
 Technology : G9 LED bulb (included)
 CRI : >90
 CCT : 2700K (Warm white)
 Lumen source : 350 lm

Product Weight 1.6 kg / 3.6 lbs

Construction
 Alabaster base
 Black wire with dimmer on cord

Certifications IP20
 ETL/ cULus pending 

Materials

 Matt black	 Polished brass
 Matt white	 Chrome plated
 Grey gloss	 Black oxidized
 Chrome plated	
 Custom	

Order code Generator	Serie	Model	Finish	Details	Voltage	QTY
HA	Hartau	TA Table	BL Matt black	BR Polished brass	1 120V	.
.	.	.	WH Matt white	OX Black oxidized	2 220-240V	.
.	.	.	WG Grey gloss	CH Chrome	.	.
.	.	.	CH Chrome	.	.	.
			ZZ Custom			

Order code :	HA	TA	—	—	—	-	—
---------------------	----	----	---	---	---	---	---